

ISSN 1726-5479

# SENSORS & TRANSDUCERS

7<sup>vol. 142</sup>  
/12



## Sensor Networks and Wireless Sensor Networks

International Frequency Sensor Association Publishing



**Editors-in-Chief:** professor Sergey Y. Yurish, tel.: +34 696067716, e-mail: editor@sensorsportal.com**Editors for Western Europe**Meijer, Gerard C.M., Delft University of Technology, The Netherlands  
Ferrari, Vittorio, Università di Brescia, Italy**Editors for North America**Datskos, Panos G., Oak Ridge National Laboratory, USA  
Fabien, J. Josse, Marquette University, USA  
Katz, Evgeny, Clarkson University, USA**Editor South America**

Costa-Felix, Rodrigo, Inmetro, Brazil

**Editor for Eastern Europe**

Sachenko, Anatoly, Ternopil State Economic University, Ukraine

**Editor for Asia**

Ohyama, Shinji, Tokyo Institute of Technology, Japan

**Editor for Africa**

Maki K.Habib, American University in Cairo, Egypt

**Editor for Asia-Pacific**

Mukhopadhyay, Subhas, Massey University, New Zealand

**Editorial Advisory Board**

- Abdul Rahim, Ruzairi**, Universiti Teknologi, Malaysia  
**Ahmad, Mohd Noor**, Northern University of Engineering, Malaysia  
**Annamalai, Karthigeyan**, National Institute of Advanced Industrial Science and Technology, Japan  
**Arcega, Francisco**, University of Zaragoza, Spain  
**Arguel, Philippe**, CNRS, France  
**Ahn, Jae-Pyoung**, Korea Institute of Science and Technology, Korea  
**Arndt, Michael**, Robert Bosch GmbH, Germany  
**Ascoli, Giorgio**, George Mason University, USA  
**Atalay, Selcuk**, Inonu University, Turkey  
**Atghiaee, Ahmad**, University of Tehran, Iran  
**Augutis, Vygtantas**, Kaunas University of Technology, Lithuania  
**Avachit, Patil Lalchand**, North Maharashtra University, India  
**Ayesh, Aladdin**, De Montfort University, UK  
**Azamimi, Azian binti Abdullah**, Universiti Malaysia Perlis, Malaysia  
**Bahreyni, Behraad**, University of Manitoba, Canada  
**Baliga, Shankar, B.**, General Motors Transnational, USA  
**Baoxian, Ye**, Zhengzhou University, China  
**Barford, Lee**, Agilent Laboratories, USA  
**Barlingay, Ravindra**, RF Arrays Systems, India  
**Basu, Sukumar**, Jadavpur University, India  
**Beck, Stephen**, University of Sheffield, UK  
**Ben Bouzid, Sihem**, Institut National de Recherche Scientifique, Tunisia  
**Benachaiba, Chellali**, Universitè de Bechar, Algeria  
**Binnie, T. David**, Napier University, UK  
**Bischoff, Gerlinde**, Inst. Analytical Chemistry, Germany  
**Bodas, Dhananjay**, IMTEK, Germany  
**Borges Carval, Nuno**, Universidade de Aveiro, Portugal  
**Bouchikhi, Benachir**, University Moulay Ismail, Morocco  
**Bousbia-Salah, Mounir**, University of Annaba, Algeria  
**Bouvet, Marcel**, CNRS – UPMC, France  
**Brudzewski, Kazimierz**, Warsaw University of Technology, Poland  
**Cai, Chenxin**, Nanjing Normal University, China  
**Cai, Qingyun**, Hunan University, China  
**Calvo-Gallego, Jaime**, Universidad de Salamanca, Spain  
**Campanella, Luigi**, University La Sapienza, Italy  
**Carvalho, Vitor**, Minho University, Portugal  
**Cecelja, Franjo**, Brunel University, London, UK  
**Cerda Belmonte, Judith**, Imperial College London, UK  
**Chakrabarty, Chandan Kumar**, Universiti Tenaga Nasional, Malaysia  
**Chakravorty, Dipankar**, Association for the Cultivation of Science, India  
**Changhai, Ru**, Harbin Engineering University, China  
**Chaudhari, Gajanan**, Shri Shivaji Science College, India  
**Chavali, Murthy**, N.I. Center for Higher Education, (N.I. University), India  
**Chen, Jiming**, Zhejiang University, China  
**Chen, Rongshun**, National Tsing Hua University, Taiwan  
**Cheng, Kuo-Sheng**, National Cheng Kung University, Taiwan  
**Chiang, Jeffrey (Cheng-Ta)**, Industrial Technol. Research Institute, Taiwan  
**Chiriac, Horia**, National Institute of Research and Development, Romania  
**Chowdhuri, Arijit**, University of Delhi, India  
**Chung, Wen-Yaw**, Chung Yuan Christian University, Taiwan  
**Corres, Jesus**, Universidad Publica de Navarra, Spain  
**Cortes, Camilo A.**, Universidad Nacional de Colombia, Colombia  
**Courtois, Christian**, Universite de Valenciennes, France  
**Cusano, Andrea**, University of Sannio, Italy  
**D'Amico, Arnaldo**, Università di Tor Vergata, Italy  
**De Stefano, Luca**, Institute for Microelectronics and Microsystem, Italy  
**Deshmukh, Kiran**, Shri Shivaji Mahavidyalaya, Barshi, India  
**Dickert, Franz L.**, Vienna University, Austria  
**Dieguez, Angel**, University of Barcelona, Spain  
**Dighavkar, C. G.**, M.G. Vidyamandir's L. V.H. College, India  
**Dimitropoulos, Panos**, University of Thessaly, Greece  
**Ding, Jianning**, Jiangsu Polytechnic University, China  
**Djordjevich, Alexander**, City University of Hong Kong, Hong Kong  
**Donato, Nicola**, University of Messina, Italy  
**Donato, Patricio**, Universidad de Mar del Plata, Argentina  
**Dong, Feng**, Tianjin University, China  
**Driljaca, Predrag**, Instersema Sensoric SA, Switzerland  
**Dubey, Venketesh**, Bournemouth University, UK  
**Enderle, Stefan**, Univ.of Ulm and KTB Mechatronics GmbH, Germany  
**Erdem, Gursan K. Arzum**, Ege University, Turkey  
**Erkmen, Aydan M.**, Middle East Technical University, Turkey  
**Estelle, Patrice**, Insa Rennes, France  
**Estrada, Horacio**, University of North Carolina, USA  
**Faiz, Adil**, INSA Lyon, France  
**Fericean, Sorin**, Balluff GmbH, Germany  
**Fernandes, Joana M.**, University of Porto, Portugal  
**Francioso, Luca**, CNR-IMM Institute for Microelectronics and Microsystems, Italy  
**Francis, Laurent**, University Catholique de Louvain, Belgium  
**Fu, Weiling**, South-Western Hospital, Chongqing, China  
**Gaura, Elena**, Coventry University, UK  
**Geng, Yanfeng**, China University of Petroleum, China  
**Gole, James**, Georgia Institute of Technology, USA  
**Gong, Hao**, National University of Singapore, Singapore  
**Gonzalez de la Rosa, Juan Jose**, University of Cadiz, Spain  
**Granell, Annette**, Goteborg University, Sweden  
**Graff, Mason**, The University of Texas at Arlington, USA  
**Guan, Shan**, Eastman Kodak, USA  
**Guillet, Bruno**, University of Caen, France  
**Guo, Zhen**, New Jersey Institute of Technology, USA  
**Gupta, Narendra Kumar**, Napier University, UK  
**Hadjiloucas, Sillas**, The University of Reading, UK  
**Haider, Mohammad R.**, Sonoma State University, USA  
**Hashsham, Syed**, Michigan State University, USA  
**Hasni, Abdelhafid**, Bechar University, Algeria  
**Hernandez, Alvaro**, University of Alcalá, Spain  
**Hernandez, Wilmar**, Universidad Politecnica de Madrid, Spain  
**Homentcovschi, Dorel**, SUNY Binghamton, USA  
**Horstman, Tom**, U.S. Automation Group, LLC, USA  
**Hsiai, Tzung (John)**, University of Southern California, USA  
**Huang, Jeng-Sheng**, Chung Yuan Christian University, Taiwan  
**Huang, Star**, National Tsing Hua University, Taiwan  
**Huang, Wei**, PSG Design Center, USA  
**Hui, David**, University of New Orleans, USA  
**Jaffrezic-Renault, Nicole**, Ecole Centrale de Lyon, France  
**James, Daniel**, Griffith University, Australia  
**Janting, Jakob**, DELTA Danish Electronics, Denmark  
**Jiang, Liudi**, University of Southampton, UK  
**Jiang, Wei**, University of Virginia, USA  
**Jiao, Zheng**, Shanghai University, China  
**John, Joachim**, IMEC, Belgium  
**Kalach, Andrew**, Voronezh Institute of Ministry of Interior, Russia  
**Kang, Moonho**, Sunmoon University, Korea South  
**Kaniasas, Eugenijus**, Vienna University of Technology, Austria  
**Katake, Anup**, Texas A&M University, USA  
**Kausel, Wilfried**, University of Music, Vienna, Austria  
**Kavasoglu, Nese**, Mugla University, Turkey  
**Ke, Cathy**, Tyndall National Institute, Ireland  
**Khelfaoui, Rachid**, Université de Bechar, Algeria  
**Khan, Asif**, Aligarh Muslim University, Aligarh, India  
**Kim, Min Young**, Kyungpook National University, Korea South  
**Ko, Sang Choon**, Electronics. and Telecom. Research Inst., Korea South  
**Kotulska, Malgorzata**, Wroclaw University of Technology, Poland  
**Kockar, Hakan**, Balikesir University, Turkey  
**Kong, Ing**, RMIT University, Australia  
**Kratz, Henrik**, Uppsala University, Sweden

**Krishnamoorthy, Ganesh**, University of Texas at Austin, USA  
**Kumar, Arun**, University of Delaware, Newark, USA  
**Kumar, Subodh**, National Physical Laboratory, India  
**Kung, Chih-Hsien**, Chang-Jung Christian University, Taiwan  
**Lacnjevac, Caslav**, University of Belgrade, Serbia  
**Lay-Ekuakille, Aime**, University of Lecce, Italy  
**Lee, Jang Myung**, Pusan National University, Korea South  
**Lee, Jun Su**, Amkor Technology, Inc. South Korea  
**Lei, Hua**, National Starch and Chemical Company, USA  
**Li, Fengyuan (Thomas)**, Purdue University, USA  
**Li, Genxi**, Nanjing University, China  
**Li, Hui**, Shanghai Jiaotong University, China  
**Li, Sihua**, Agiltron, Inc., USA  
**Li, Xian-Fang**, Central South University, China  
**Li, Yuefa**, Wayne State University, USA  
**Liang, Yuanchang**, University of Washington, USA  
**Liawruangrath, Saisunee**, Chiang Mai University, Thailand  
**Liew, Kim Meow**, City University of Hong Kong, Hong Kong  
**Lin, Hermann**, National Kaohsiung University, Taiwan  
**Lin, Paul**, Cleveland State University, USA  
**Linderholm, Pontus**, EPFL - Microsystems Laboratory, Switzerland  
**Liu, Aihua**, University of Oklahoma, USA  
**Liu Changgeng**, Louisiana State University, USA  
**Liu, Cheng-Hsien**, National Tsing Hua University, Taiwan  
**Liu, Songqin**, Southeast University, China  
**Lodeiro, Carlos**, University of Vigo, Spain  
**Lorenzo, Maria Encarnacio**, Universidad Autonoma de Madrid, Spain  
**Lukaszewicz, Jerzy Pawel**, Nicholas Copernicus University, Poland  
**Ma, Zhanfang**, Northeast Normal University, China  
**Majstorovic, Vidosav**, University of Belgrade, Serbia  
**Malyshev, V.V.**, National Research Centre 'Kurchatov Institute', Russia  
**Marquez, Alfredo**, Centro de Investigacion en Materiales Avanzados, Mexico  
**Matay, Ladislav**, Slovak Academy of Sciences, Slovakia  
**Mathur, Prafull**, National Physical Laboratory, India  
**Maurya, D.K.**, Institute of Materials Research and Engineering, Singapore  
**Mekid, Samir**, University of Manchester, UK  
**Melnyk, Ivan**, Photon Control Inc., Canada  
**Mendes, Paulo**, University of Minho, Portugal  
**Mennell, Julie**, Northumbria University, UK  
**Mi, Bin**, Boston Scientific Corporation, USA  
**Minas, Graca**, University of Minho, Portugal  
**Mishra, Vivekanand**, National Institute of Technology, India  
**Moghavvemi, Mahmoud**, University of Malaya, Malaysia  
**Mohammadi, Mohammad-Reza**, University of Cambridge, UK  
**Molina Flores, Esteban**, Benemérita Universidad Autónoma de Puebla, Mexico  
**Moradi, Majid**, University of Kerman, Iran  
**Morello, Rosario**, University "Mediterranea" of Reggio Calabria, Italy  
**Mounir, Ben Ali**, University of Sousse, Tunisia  
**Mrad, Nezh**, Defence R&D, Canada  
**Mulla, Imtiaz Sirajuddin**, National Chemical Laboratory, Pune, India  
**Nabok, Aleksey**, Sheffield Hallam University, UK  
**Neelamegam, Periasamy**, Sastra Deemed University, India  
**Neshkova, Milka**, Bulgarian Academy of Sciences, Bulgaria  
**Oberhammer, Joachim**, Royal Institute of Technology, Sweden  
**Ould Lahoucine, Cherif**, University of Guelma, Algeria  
**Pamidighanta, Sayanu**, Bharat Electronics Limited (BEL), India  
**Pan, Jisheng**, Institute of Materials Research & Engineering, Singapore  
**Park, Joon-Shik**, Korea Electronics Technology Institute, Korea South  
**Passaro, Vittorio M. N.**, Politecnico di Bari, Italy  
**Penza, Michele**, ENEA C.R., Italy  
**Pereira, Jose Miguel**, Instituto Politecnico de Setebal, Portugal  
**Petsev, Dimiter**, University of New Mexico, USA  
**Pogacnik, Lea**, University of Ljubljana, Slovenia  
**Post, Michael**, National Research Council, Canada  
**Prance, Robert**, University of Sussex, UK  
**Prasad, Ambika**, Gulbarga University, India  
**Prateepasen, Asa**, Kingmoungut's University of Technology, Thailand  
**Pugno, Nicola M.**, Politecnico di Torino, Italy  
**Pullini, Daniele**, Centro Ricerche FIAT, Italy  
**Pumera, Martin**, National Institute for Materials Science, Japan  
**Radhakrishnan, S.**, National Chemical Laboratory, Pune, India  
**Rajanna, K.**, Indian Institute of Science, India  
**Ramadan, Qasem**, Institute of Microelectronics, Singapore  
**Rao, Basuthkar**, Tata Inst. of Fundamental Research, India  
**Raouf, Kosai**, Joseph Fourier University of Grenoble, France  
**Rastogi Shiva, K.**, University of Idaho, USA  
**Reig, Candid**, University of Valencia, Spain  
**Restivo, Maria Teresa**, University of Porto, Portugal  
**Robert, Michel**, University Henri Poincare, France  
**Rezazadeh, Ghader**, Urmia University, Iran  
**Royo, Santiago**, Universitat Politècnica de Catalunya, Spain  
**Rodriguez, Angel**, Universitat Politècnica de Catalunya, Spain  
**Rothberg, Steve**, Loughborough University, UK  
**Sadana, Ajit**, University of Mississippi, USA  
**Sadeghian Marnani, Hamed**, TU Delft, The Netherlands  
**Sapozhnikova, Ksenia**, D.I.Mendeleyev Institute for Metrology, Russia  
**Sandacci, Serghei**, Sensor Technology Ltd., UK  
**Saxena, Vibha**, Bbhba Atomic Research Centre, Mumbai, India  
**Schneider, John K.**, Ultra-Scan Corporation, USA  
**Sengupta, Deepak**, Advance Bio-Photonics, India  
**Seif, Selemani**, Alabama A & M University, USA  
**Seifter, Achim**, Los Alamos National Laboratory, USA  
**Shah, Kriyang**, La Trobe University, Australia  
**Sankarraaj, Anand**, Detector Electronics Corp., USA  
**Silva Giraó, Pedro**, Technical University of Lisbon, Portugal  
**Singh, V. R.**, National Physical Laboratory, India  
**Slomovitz, Daniel**, UTE, Uruguay  
**Smith, Martin**, Open University, UK  
**Soleimanpour, Amir Masoud**, University of Toledo, USA  
**Soleymanpour, Ahmad**, University of Toledo, USA  
**Somani, Prakash R.**, Centre for Materials for Electronics Technol., India  
**Sridharan, M.**, Sastra University, India  
**Srinivas, Talabattula**, Indian Institute of Science, Bangalore, India  
**Srivastava, Arvind K.**, NanoSonix Inc., USA  
**Stefan-van Staden, Raluca-Ioana**, University of Pretoria, South Africa  
**Stefanescu, Dan Mihai**, Romanian Measurement Society, Romania  
**Sumriddetchka, Sarun**, National Electronics and Comp. Technol. Center, Thailand  
**Sun, Chengliang**, Polytechnic University, Hong-Kong  
**Sun, Dongming**, Jilin University, China  
**Sun, Junhua**, Beijing University of Aeronautics and Astronautics, China  
**Sun, Zhiqiang**, Central South University, China  
**Suri, C. Raman**, Institute of Microbial Technology, India  
**Sysoev, Victor**, Saratov State Technical University, Russia  
**Szewczyk, Roman**, Industr. Research Inst. for Automation and Measurement, Poland  
**Tan, Ooi Kiang**, Nanyang Technological University, Singapore  
**Tang, Dianping**, Southwest University, China  
**Tang, Jaw-Luen**, National Chung Cheng University, Taiwan  
**Teker, Kasif**, Frostburg State University, USA  
**Thirunavukkarasu, I.**, Manipal University Karnataka, India  
**Thumbavanam Pad, Kartik**, Carnegie Mellon University, USA  
**Tian, Gui Yun**, University of Newcastle, UK  
**Tsiantos, Vasilios**, Technological Educational Institute of Kaval, Greece  
**Tsigara, Anna**, National Hellenic Research Foundation, Greece  
**Twomey, Karen**, University College Cork, Ireland  
**Valente, Antonio**, University, Vila Real, - U.T.A.D., Portugal  
**Vanga, Raghav Rao**, Summit Technology Services, Inc., USA  
**Vaseashta, Ashok**, Marshall University, USA  
**Vazquez, Carmen**, Carlos III University in Madrid, Spain  
**Vieira, Manuela**, Instituto Superior de Engenharia de Lisboa, Portugal  
**Vigna, Benedetto**, STMicroelectronics, Italy  
**Vrba, Radimir**, Brno University of Technology, Czech Republic  
**Wandelt, Barbara**, Technical University of Lodz, Poland  
**Wang, Jiangping**, Xi'an Shiyou University, China  
**Wang, Kedong**, Beihang University, China  
**Wang, Liang**, Pacific Northwest National Laboratory, USA  
**Wang, Mi**, University of Leeds, UK  
**Wang, Shinn-Fwu**, Ching Yun University, Taiwan  
**Wang, Wei-Chih**, University of Washington, USA  
**Wang, Wensheng**, University of Pennsylvania, USA  
**Watson, Steven**, Center for NanoSpace Technologies Inc., USA  
**Weiping, Yan**, Dalian University of Technology, China  
**Wells, Stephen**, Southern Company Services, USA  
**Wolkenberg, Andrzej**, Institute of Electron Technology, Poland  
**Woods, R. Clive**, Louisiana State University, USA  
**Wu, DerHo**, National Pingtung Univ. of Science and Technology, Taiwan  
**Wu, Zhaoyang**, Hunan University, China  
**Xiu Tao, Ge**, Chuzhou University, China  
**Xu, Lisheng**, The Chinese University of Hong Kong, Hong Kong  
**Xu, Sen**, Drexel University, USA  
**Xu, Tao**, University of California, Irvine, USA  
**Yang, Dongfang**, National Research Council, Canada  
**Yang, Shuang-Hua**, Loughborough University, UK  
**Yang, Wuqiang**, The University of Manchester, UK  
**Yang, Xiaoling**, University of Georgia, Athens, GA, USA  
**Yaping Dan**, Harvard University, USA  
**Ymeti, Aurel**, University of Twente, Netherland  
**Yong Zhao**, Northeastern University, China  
**Yu, Haihu**, Wuhan University of Technology, China  
**Yuan, Yong**, Massey University, New Zealand  
**Yufera Garcia, Alberto**, Seville University, Spain  
**Zakaria, Zulkarnay**, University Malaysia Perlis, Malaysia  
**Zagnoni, Michele**, University of Southampton, UK  
**Zamani, Cyrus**, Universitat de Barcelona, Spain  
**Zeni, Luigi**, Second University of Naples, Italy  
**Zhang, Minglong**, Shanghai University, China  
**Zhang, Quintao**, University of California at Berkeley, USA  
**Zhang, Weiping**, Shanghai Jiao Tong University, China  
**Zhang, Wenming**, Shanghai Jiao Tong University, China  
**Zhang, Xueji**, World Precision Instruments, Inc., USA  
**Zhong, Haoxiang**, Henan Normal University, China  
**Zhu, Qing**, Fujifilm Dimatix, Inc., USA  
**Zorzano, Luis**, Universidad de La Rioja, Spain  
**Zourob, Mohammed**, University of Cambridge, UK

# Contents

Volume 142  
Issue 7  
July 2012

www.sensorsportal.com

ISSN 1726-5479

## Editorial Book Review

### Non-Dispersive Infrared Gas Measurement

*Sergey Y. Yurish, International Frequency Sensor Association (IFSA)* ..... 1

## Research Articles

### Research in Nanothermometry. Part 6. Metrology of Raman Thermometer with Universal Calibration Artifacts

*Bohdan Stadnyk, Svyatoslav Yatsyshyn, Oleh Sehedra* ..... 1

### A Survey of Power-Efficient Gathering of Sensor Information System Based Routing Protocols of Wireless Sensor Networks

*Muktar Hussaini, Farhat Anwar, Aisha Hassan A. H.* ..... 10

### Comparative Analysis of Energy-efficient Cluster-based Routing Protocols for Wireless Sensor Networks

*Naveen Kumar V and Santhi Prabha I* ..... 23

### TDMA Based Slotted Medium Access Control Protocol for Wireless Sensor Networks

*Prasan Kumar Sahoo* ..... 33

### Circuit of Data Aggregation on the Fly for WSN

*M. Daoui, M. Lalam, S. Hamrioui B. Djama and D. Nouali* ..... 44

### Dynamic Analysis of Wireless Sensor Network Programs Based on Binary Tool and Simulator

*Yuxia Sun, Yong Tang* ..... 54

### Circle Intersection Method Combined with Fuzzy Weighted Centroid Method for Localization in WSNs

*Mohan Kumar J, P.R. Venkateswaran, N. Gopalakrishna Kini, Sundaresan C.* ..... 61

### Development of an Automatic Wireless System Applied for Soil Temperature Measurement

*S. Makhlof, M. Laghrouche* ..... 69

### Theoretical Analysis to Capacitance of RF MEMS Clamped-Clamped Capacitive Switch

*Tian-Jie, Cao* ..... 76

### Deployment of Wireless Sensor Network for the Measurement of Exhaled Nitric Oxide in In-home Healthcare

*Elango Surendran, Mathivanan Natarajan, Arun Venkatesh Krishna, Vairamani Kanagavel, Karunakaran Chandran, Madasamy Thangamuthu, Pandiaraj Manickam.* ..... 87

### Wireless Communication Solution for Health Care Equipment

*Tiago Faustino Andrade, Manuel Rodrigues Quintas, Carlos Moreira da Silva, Maria Teresa Restivo, Maria de Fátima Chouzal and Teresa Maria Amaral* ..... 95

<b>Lateral Control of Aircraft, Considering the Cross-coupling Effect of Yaw and Roll on Each-other Using Fuzzy Logic</b> <i>Vishnu G. Nair, V. I. George, Prahlad K. R.</i> .....	105
<b>A Parametric Study of S- tube Coriolis Mass Flow Meter</b> <i>Arvind K. Rajput, Satish C. Sharma, Marut Shukla, Souvik Roy</i> .....	118
<b>Calibration Method on Machine for Multi-axis Heavy Force Sensor</b> <i>Wei liu, Zhenyuan jia and Qi li</i> .....	130
<b>TiO<sub>2</sub> Thin Film Capacitive Humidity Sensor Based on Sol-gel Technique</b> <i>Manju Pandey, Debdulal Saha, Kamalendu Sengupta, S. S. Islam</i> .....	143

Authors are encouraged to submit article in MS Word (doc) and Acrobat (pdf) formats by e-mail: editor@sensorsportal.com  
Please visit journal's webpage with preparation instructions: <http://www.sensorsportal.com/HTML/DIGEST/Submission.htm>

International Frequency Sensor Association (IFSA).

## Inertial Combo Sensors for Consumer & Automotive

### Technology, Applications, Industry & Market Report to 2016



*This report is focused on the analysis of the opportunities and the challenges for inertial combo sensors in those high-volume market areas.*

[http://www.sensorsportal.com/HTML/Inertial\\_Combo\\_Sensors\\_Market.htm](http://www.sensorsportal.com/HTML/Inertial_Combo_Sensors_Market.htm)

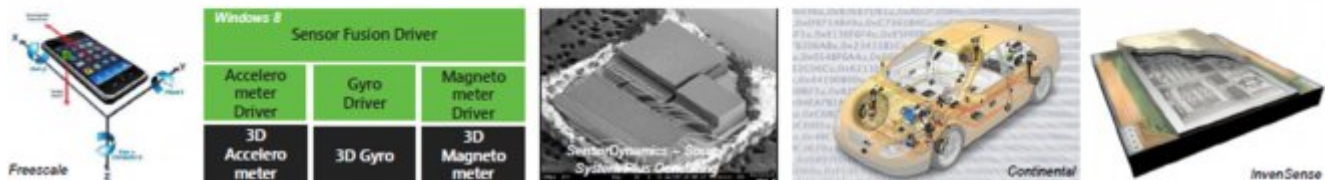

## Uncooled Infrared Imaging Market: Commercial & Military applications

### Market & Technology Report to 2016



*This new 2011 IR report, is an updated and in depth analysis of commercial markets covered in the 2010 report in addition we have included a new analysis of the military markets.*

[http://www.sensorsportal.com/HTML/Detectors\\_for\\_Thermography.htm](http://www.sensorsportal.com/HTML/Detectors_for_Thermography.htm)



## TDMA Based Slotted Medium Access Control Protocol for Wireless Sensor Networks

**Prasan Kumar Sahoo**

Department of Computer Science and Information Engineering,  
Chang Gung University, Kwei-Shan, Taiwan, 33302, R.O.C.

Tel.: 886-3-2118800, fax: 886-3-2118668

E-mail: pksahoo@mail.cgu.edu.tw

*Received: 16 March 2012 /Accepted: 26 March 2012 /Published: 31 July 2012*

---

**Abstract:** Wireless Sensor Network (WSN) is an emerging technology, which has a wide range of potential applications starting from surveillance to health monitoring. Sensor nodes in WSN are always power constraint as they are operated with batteries. Hence, it is prudent to design energy efficient medium access control (MAC) protocols for the WSN to improve the network lifetime. In this paper, an energy efficient MAC protocol for the wireless sensor network is proposed that allocate slots dynamically to minimize the idle states of the sensors. The proposed protocol assists each node to decide when and how to access the channel. The proposed idea is TDMA based and the slots are allocated efficiently based on the traffic loads and to maintain the fairness. In our protocol, energy efficiency is maintained by turning off the radio to sleep mode whenever necessary and at the same time maintains the synchronization. In the proposed method, best efforts are made to reduce energy wastage from various sources by adopting proper synchronization among the nodes and thereby improving energy efficiency. *Copyright © 2012 IFSA.*

**Keywords:** Wireless sensor network, TDMA, MAC protocol, Slotted, Energy efficient.

---

### 1. Introduction

Recent advances in hardware and software for the wireless network technologies have enabled the development of small sized, low-power, low-cost and multi-functional sensor nodes [1], which consist of sensing, data processing and wireless communicating components. These nodes are operated with very low powered batteries and are deployed hundreds to thousands to form the wireless sensor network (WSN). In WSN, nodes form the network dynamically without help of any infrastructure and are deployed randomly. Those nodes are supposed to sense a phenomenon, process the collected data

in a collaborative manner, and should route the results to an end user. Typical applications of wireless sensor networks are the environmental monitoring, military surveillance, health monitoring, target tracking, inventory management, and many more [2-4]. It is envisioned that the sensor network is used to collect useful information in physical environments over a long time period for scientific data analysis, where battery is the main source of energy for the sensor nodes. However, sensors have limited energy and it is difficult to recharge or replace the battery after deploying them over a hostile environment or in harsh terrains. However, it is expected that the sensor network systems should monitor the area for a long time after deployment. Therefore, energy efficiency plays an important role in WSNs.

For achieving energy efficiency, scheduling is one of the solutions in WSNs. In scheduling, normally subsets of sensors have to be active for a certain period of time such that each subset can guarantee the coverage and connectivity and can maximize the network lifetime. However, a common challenge in wireless networks is collision, resulting from two nodes sending data at the same time over the same transmission medium. Hence, medium access control in all shared-medium such as wireless networks is an important technique that enables the successful operation of the network. Normally, MAC protocols are developed to assist each node to decide when and how to access the channel. This problem is also known as channel allocation or multiple access problems. The MAC layer is considered as a sub layer of the data link layer in the network protocol stack and the main goal of designing an efficient MAC protocol is to avoid collisions from interfering nodes. Besides, the medium access decision in a dense network of nodes with low duty-cycles is a challenging problem, which must be solved in an energy-efficient manner [5]. Since, communication in sensor network causes more energy consumption than computation, it is essential to minimize the cost of communication to satisfy the desired network operations. Generally, an efficient MAC protocol can save large amount of energy because of the appropriate sleep and wake-up schedules.

Design of MAC protocols are divided into contention-based and reservation-based. There are quite varieties of MAC protocols designed recently, which are developed for wireless voice and data communication networks. The most popular contention free based protocols are the time-division multiple access (TDMA), code-division multiple access (CDMA), and frequency division multiple access (FDMA). Their basic idea is to avoid interference by scheduling nodes onto different sub-channels that are divided either by time, frequency or orthogonal codes. Since these sub-channels do not interfere with each other, MAC protocols in this group are collision-free. Another class of contention-based protocols like IEEE 802.11MAC is based on contention rather than pre-allocate transmissions. In contention-based methods like IEEE 802.11 protocols, nodes compete for a shared channel, resulting in probabilistic coordination. In CSMA, a node listens to the channel before transmitting and may wait for a long time. Nodes still waste lots of power being idle for a long time and wait for the possible traffic to receive, though, no traffic is sent to it. Previous studies [6] show that the idle listening consumes more energy as compared to the energy consumption for receiving data. In the reservation-based schemes, generally sensor nodes are assigned to fixed channels, such as TDMA-based and LEACH [7] protocols. It is not easy to modify its frame length and time slot assignment dynamically, if number of nodes within a cluster changes. Hence, its scalability is not as good as that of the contention-based protocols.

A simple solution to extending network lifetime is to operate the nodes in a duty-cycled manner with periodic switching between sleep and wake-up modes. While synchronization of such sleep schedules is challenging in itself, a larger concern is that arbitrarily long sleep periods can reduce the responsiveness and effectiveness of the sensors. In applications where it is critical that certain events in the environment be detected and reported rapidly, the latency induced by sleep schedules must be kept within strict bounds, even in the presence of network congestion. A simple solution to extend network lifetime is to operate the nodes in a duty-cycled manner with periodic switching between sleep and wake-up modes. While synchronization of such sleep schedules is challenging in itself, a larger

concern is that arbitrarily long sleep periods can reduce the responsiveness and effectiveness of the sensors. In applications where it is critical that certain events in the environment be detected and reported rapidly, the latency induced by sleep schedules must be kept within strict bounds, even in the presence of network congestion. Since, energy efficiency is the foremost criteria for wireless sensor networks, efforts for efficient usage of energy are mainly focused on reducing the collision by switching to low power node and to be favorably adapted to changes in traffic. However, the traffic adaptive medium access protocols as proposed earlier are TDMA based protocol that has been designed for energy efficient collision free channels in WSN. In this paper, an efficient TDMA based MAC protocol is proposed to reduce the power consumption by ensuring collision free transmission and by switching the nodes to low power idle state when they are not transmitting or receiving.

The remainder of the paper is organized as follows. Related works of different medium access protocols of WSN are discussed in Section 2. The system model and our proposed MAC protocol are described in Section 3. Performance evaluation of the proposed MAC is given in Section 4. Conclusions are made in Section 5 of the paper.

## **2. Related Work**

All medium-access control (MAC) protocols for wireless networks manage the usage of the radio interface to ensure efficient utilization of the shared bandwidth. MAC protocols designed for wireless sensor networks have an additional goal of managing radio activity to conserve energy. Thus, while traditional MAC protocols must balance throughput, delay, and fairness concerns, WSN MAC protocols place an emphasis on energy efficiency as well. So far, lots of efforts are made by different researchers in the field of designing an efficient MAC protocol. Scheduled based MAC protocols are either based on polling or multiplexing to avoid energy waste caused by collisions but introduces polling overhead and delays. In case of multiplexing, channels are pre-allocated based on time, frequency, or code multiplexing. Scheduling based approaches often form clusters with cluster controllers responsible for the channel allocation. Since only a certain number of channels can be allocated the scalability might be limited then. On the contrary, contention-based protocols allow sharing channels and allocating channels on-demand. But, collision avoidance is difficult to achieve in WSNs due to hidden nodes and densely deployed nature of the sensors. Though these protocols are simple, scalable and flexible, their major drawback is a high idle listening time.

Various MAC protocols proposed so far for wireless communication come under the above both categories. Besides, several MAC protocols designed specifically for the wireless sensor networks. Authors in [6] propose the Sensor-MAC(S-MAC) based on IEEE 802.11 protocols, which is specifically designed to reduce the energy wastage. The basic idea in this protocol is that the time is divided into fairly frames, which has active and sleeping intervals. Each sensor node communicates with another during the active interval and turns off its radio during sleep interval. It enables the nodes to operate at low duty cycle by putting them into periodic sleep instead of idle listening. Although, S-MAC conserves more energy than IEEE 802.11 MAC mechanism, the fixed duty cycle increases the latency and cannot sustain the heavy traffic load. To minimize the number of duty-cycles of S-MAC, authors in [8] improve the idle listening by using variable length of time, and propose the Timeout-MAC (T-MAC). According to this protocol, if no activity is found for certain time duration in the vicinity of a node, it goes to sleep state. Though, the burden of selecting appropriate duty-cycle is reduced, the latency in T-MAC increases, as the data arrived during sleep cycle is queued until the next active cycle is started.

An adaptive mechanism that determines the sleep and wake-up schedules for a node based on its own traffic and the traffic patterns of its neighbors is proposed in Pattern-MAC (P-MAC) [9]. P-MAC changes the periodic fixed duty cycle and is able to achieve a better throughput under high traffic load

and conserves more energy under light traffic load than S-MAC and T-MAC. However, a large control packet overhead is involved in P-MAC, which reduces the throughput and creates a burden under high traffic load. Though, most of the MAC protocols are proposed for the static sensor nodes, MMAC [10] focuses on mobile sensors. As proposed in MMAC, it can handle both strong as well as weak mobility of nodes. Strong mobility refers to frequent topology changes due to concurrent addition of nodes to the existing network, and physical mobility either because of mobility in the medium or by means of special motion hardware. Weak mobility refers to regular topology changes. Node joins to the network and may be dead after certain duration of time. In MMAC, nodes are allowed to transmit at particular time-slots, based on the traffic information and mobility pattern of the nodes. This makes MMAC a scheduling-based protocol and thus guarantees collision avoidance. MMAC uses a distributed contention based algorithm that affects transmission rights of a node at particular time-slots based on traffic information and mobility pattern of the nodes. It adapts the frame-time, transmission slots and random-access slots according to mobility of nodes and is designed in such a way that if a large number of nodes are expected to enter or leave the two hop neighborhood of a node, then the frame time can be reduced and vice versa.

A Traffic-Adaptive Medium Access (TRAMA) protocol [11] is proposed for the WSN, which provides energy-efficient conflict free channel access mechanism in wireless sensor networks. It employs a traffic adaptive distributed election scheme that selects receivers based on schedules announced by transmitters. Nodes using TRAMA exchange their two-hop neighborhood information and the transmission schedules specifies which nodes are the possible receivers of their traffic in an order. Though, TRAMA is energy efficient while maintaining good throughput, acceptable latencies, and fairness, it suffers with several disadvantages. The main drawback in TRAMA is the overhead due to explicit schedule propagation. Besides, since every node calculates each of its 2-hop neighbor's priorities, it has a high duty cycle and to accommodate topological changes, TRAMA alternates between random and scheduled access and thus consumes more energy.  $\mu$ -MAC [12] shares a common architecture with TRAMA, though the communication channel in  $\mu$ -MAC is divided into a contention and a contention-free period. It addresses the problem of achieving very low radio duty-cycles in sensor nodes, but simultaneously provides good delivery rates, low buffering requirements and delay characteristics that can support several real world applications.  $\mu$ -MAC considers traffic behavior of the wireless sensor networks to increase the efficiency of radio utilization and thus reduce the duty-cycles. Though it aims at maximizing sleep ratios while keeping message latency and reliability at acceptable levels, it heavily relies on information provided by upper layers to improve its radio utilization.

B-MAC [13] proposes a set of core functionality and an interface that allows the core components to be tuned and configured depending on higher-layer needs. B-MAC comprises features like low-power listening, and clear channel assessment, which determines whether the channel is busy or not by examining multiple adjacent samples and using an appropriate detection technique. B-MAC is a light-weight protocol that provides an interface to the applications for implementing their own MAC. It can minimize the idle listening to improve the energy efficiency and to have higher throughput. An application-specific solution is provided by the data-gathering MAC (D-MAC) [14], which applies only to flow on a predetermined data-gathering tree going up from the various network nodes to a common sink. It proposes a different form of sleep schedule, where nodes at each successive level up the tree and follow a receive-transmit-sleep sequence that is shifted to the right. It allows data and control packets to sequentially traverse all the way up a tree with minimum delay and allows requests for adaptive extensions of the active period to be propagated all the way up the tree, thereby reduces the interference by separating active periods at the different levels. However, it is not a general purpose MAC as it applies only to one-way data-gathering trees. From the study of different researchers, it is evident that to improve the energy efficiency of sensors, several factors such as idle listening, overhearing, and collision should be minimized. Hence, in this paper we propose a slotted

MAC protocol to dynamically allocate the slots to different nodes based on the number of nodes that want to communicate data and ensure fairness and reduce idle listening to the best possible extent.

### 3. Proposed MAC Protocol

#### 3.1. System Model

Consider a multi hop wireless sensor networks, where a sensor may have several nodes as its neighbors. It is assumed that the whole network is divided into several clusters and each cluster has a head, which is considered as the data allocator in our protocol. For allocating slots dynamically and more efficiently, an allocator is selected among all nodes present in a cluster. As shown in Fig. 1, let 'O' be a cluster head and therefore is an allocator among its one hop neighbors. Let, A, B, C, D and E be the one-hop, M, N, P, Q and R are be the two-hop and K and L be the three-hop neighbors of allocator node 'O'. Thus each node has one and two hop neighbors as in case of node 'O'. It is assumed that a node may have to receive data sent from a single receiver or from multiple receives at the same time. Besides, the data have to pass through the allocator node as they may not be directly connected to each other. For example, as shown in Fig. 1, node B may have data from node A or from nodes A and C. Since, node B is connected to nodes A and C directly, it has to transmit its data through the allocator node 'O' in a multi-hop fashion. Based on the traffic load of different sensors that are directly connected to 'O', allocator 'O' has to analyze the traffic of each of its neighbors and has to allocate different number slots to its one hop neighbors.

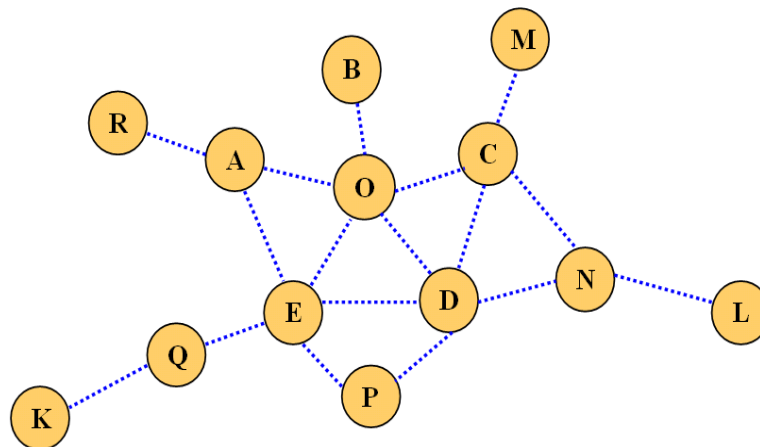

**Fig. 1.** A multi-hop WSN with node 'O' as the cluster head (Allocator).

#### 3.2. The MAC Protocol

Energy efficiency is an important bottleneck of wireless sensor networks. In order to minimize the energy consumption of nodes in a wireless sensor networks, we design here a protocol that avoids the collision, idle listening, and overhearing. In this section, a TDMA based MAC protocol is proposed to allocate slots to the nodes based on their priority and at the same time, it maintains the fairness. By allocating specified number of slots to the nodes having data to transmit, overhearing and idle listening are reduced. Besides, attempts are made in our protocol to allocate slots to the nodes based on their requirements by ensuring collision avoidance. Initially, all nodes in a cluster are in the active state and synchronize with the cluster head to transmit the control message to it. It is to be noted that cluster head of a cluster is the allocator that decides the number slots to be allocated to different sensors of that cluster based on their demands. Nodes of a cluster having data to transmit to the nodes of the same

or different cluster send the *Request\_To\_Allot (RTA)* message to the allocator. Then, allocator node sends a *Clear\_To\_Allot (CTA)* message to the node, which has requested the time slots. In the RTA packet, a node has to put the ID of the destination node, amount of data it wants to send and duration of its transmission in form of slots. Then, the allocator has to decide the number of slots based on its priority, availability of slots and demands of slots by other nodes of the same cluster.

As shown in Fig. 2, node 'A' first sends the *RTA* packet to allocator 'O', which is responded by a *CTA* packet to node A. When the *CTA* packet is sent to node A, all nodes within communication range of 'O' can receive it and go to the sleep state for certain duration of time as defined by the allocator in the *CTA* packet. Then node 'A' gets the right to use the channel for a specific duration of time as defined by 'O' and is based on its demand. For example, suppose node 'A' needs 't' units of time to transmit data to a destination node, which is informed to 'O' by means of the *RTA* packet. Then 'O' broadcasts the *CTA* packet as the control message to its entire neighbors that specifies the duration of time that node 'A' has to use the channel. Upon receiving this control message, other nodes except 'A' will go to the sleep state. However, before going to the sleep state, other nodes send their acknowledgement (*ACK*) to the allocator and mention about their requirements to use the channel. Since, in a cluster, only one node remains in active state at a time, collision among other nodes is reduced.

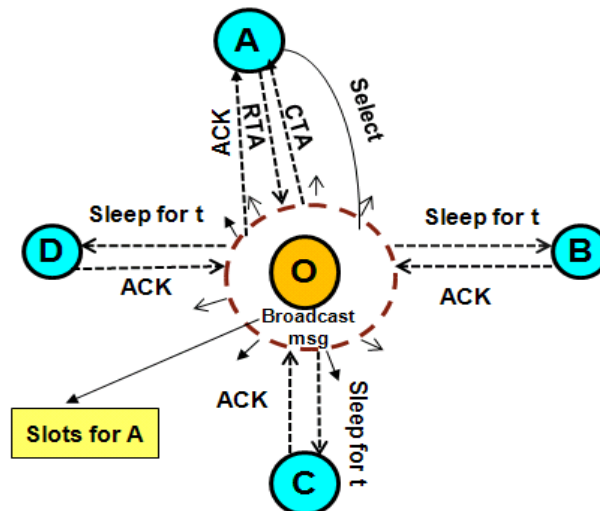

**Fig. 2.** Negotiation and allocation of slots between the allocator and its one-hop neighbors.

It is to be noted that the allocator decides how efficiently it can assign slots to its neighbors so that all nodes can get a fair share to access the channel and can synchronize with it after transmission of data by a node of the cluster. Hence, it is prime duty of the allocator to assign slots based on the quantity of data that a neighbor wants to transmit. If the allocator assigns slots in FCFS (First Come First Served) pattern, nodes which come last have to starve, even though it requires minimum number of slots. Hence, solution to this is to adopt the Round-Robin scheduling algorithm, by which all nodes irrespective of their quantity of data can be given equal chances to get the required number of slots. As per this slotted scheduling mechanism, each node will be allotted slots partially as per their need, but in a phase-by-phase manner. Thus, by implementing this scheme fairness can be maintained properly as no node can be starved. For example, as shown in Fig. 3, node 'D' and 'E' require less number of slots to transmit their data as compared to others nodes of the cluster. Hence, by using FCFS scheduling, obviously nodes 'D' and 'E' will suffer from starvation.

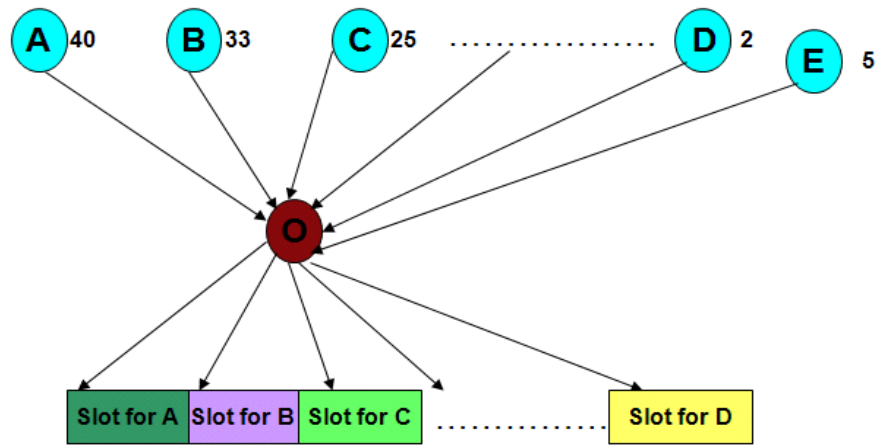

Fig. 3. Example showing starvation of nodes due to inefficient slotted mechanism.

In order to minimize starvation and to maintain the fairness among nodes, the allocator has to divide all requested slots into segments with minimum requested number of slots. For example, as shown in Fig. 4, let A, B, C and D be four one-hop neighbors of an allocator node ‘O’. Suppose, node A, B, and D have 5, 10, and 15 units of packets to transmit to receivers R<sub>1</sub>, R<sub>2</sub> and R<sub>3</sub>, respectively. Here, node C has no data to transmit and therefore it does not make any request, whereas nodes A, B, C and D send their request through the *RTA* packet to the allocator ‘O’. Since, 5 is the minimum number of requested packets, allocator ‘O’ divided 5, 10 and 15 packets in the multiple of 5 and allocate only 5 packets to each node. Then using Round-Robin scheduling algorithm, it allocates the slots to the nodes to use the channel so that fairness is maintained and no node remains starved.

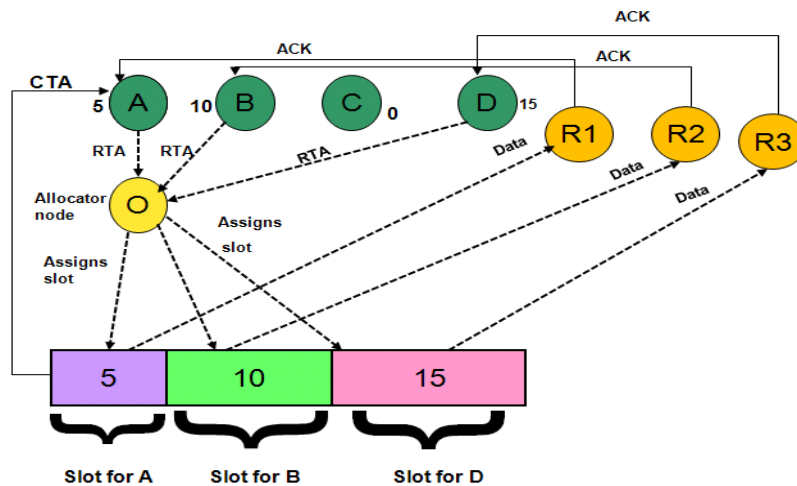

Fig. 4. Allocation of slots and allotment of nodes using Round-Robin scheduling.

#### 4. Performance Evaluation

In this section, we evaluate the energy consumption, and latency of S-MAC, T-MAC, TRAMA and our protocol by means of simulation. Our protocol is simulated using NS 2.29 [15]. A network area of size 100 m × 100 m is considered for the simulation, where 50 sensor nodes are distributed randomly. The communication range of each node is fixed as 10 m. The transmitting power is set to be 2 W, receiving power is 1W, idle power is 1 W and the sleeping power is set to be 0.001 W. It is assumed that each node has initial energy of 1000 Joules. The bandwidth is set to be 20 kbps and each control

packet size and data packet size is kept to be 10 bytes and 512 bytes, respectively. The default duty cycle is set to be 10 % as same as S-MAC. We also measure the metrics under different traffic loads in the network. The two major performance metrics that we have used in our simulation are the average energy consumption, which is the aggregate average energy consumed by all nodes of the entire network with packet inter-arrival rates. We describe our simulation results as follows.

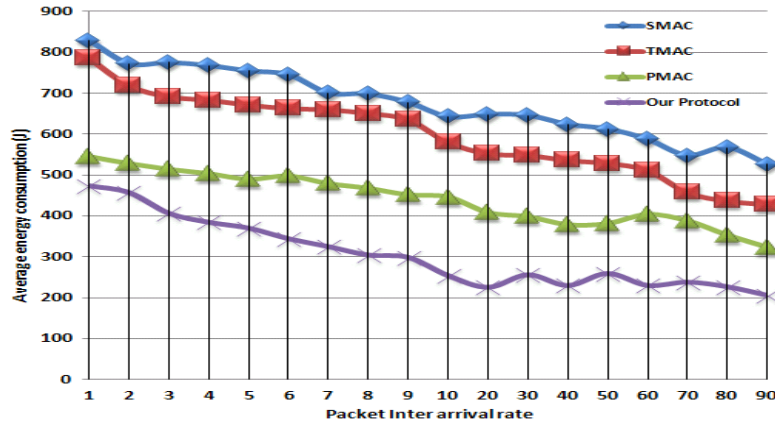

Fig. 5. Average energy consumption with inter packet arrival rates.

In our simulation, we have analyzed the average energy consumption and average end-to-end transmission delays for the different values of inter packet arrival rates. The packet inter-arrival rate is considered as the interval between two packets sent from one node to another. The energy consumption for different MAC protocols with inter packet arrival rates is shown in Fig. 5. It is observed that TMAC saves more energy than SMAC, as the sensors sleep after a pre-defined period of idle listening time is elapsed. Because of the adjustment of active and sleep schedules, energy saving in PMAC is better than TMAC. More energy is saved in our protocol, since each node wakes up in limited slots instead of being active during the whole listening intervals. Moreover, in our protocol, energy conservation in a heavy traffic environment is more significant.

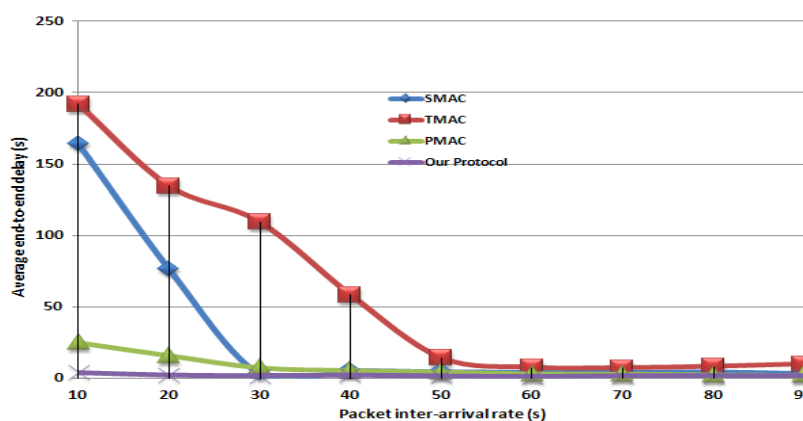

Fig. 6. Average end-to-end delay with inter packet arrival rates.

The simulation results for the end-to-end delay for different packet arrival rates are shown in Fig. 6. It is to be noted that the delay decreases when packet inter-arrival rate increases. From the simulation results, it is observed that the latency in TMAC is worse than SMAC, since the premature elimination of the active time in TMAC causes longer sleeping interval in SMAC. On the other hand, PMAC is

better than SMAC and TMAC, since it can adjust the wake-up schedules based on their neighbor scheduling pattern. Under heavy traffic load, collision will cause packet delay. Therefore, sensor nodes in PMAC updating their pattern in every wake-up time slot, causes more delay than our MAC protocol. The simulation results of energy consumption for different ratio of duty cycles are shown in Fig. 7. From the figure, it is found that more energy could be consumed, if duty cycle is increased. It is observed that SMAC and TMAC have less power saving than PMAC and our protocol. We can see that the energy consumption of those protocols is very high after about 80 % of the duty cycle. Measurement of end-to-end delay is shown in Fig. 8. It is found that our protocol outperforms over other MAC protocols, because of the alter time of the next-hop to send packets continuously. The energy wastage increases rapidly after the duty cycle achieves to 20 % and almost out of power at 80 %, and the latency will work better when the value is less than 40 %. We notice that those protocols work well when the duty cycle is 10 %.

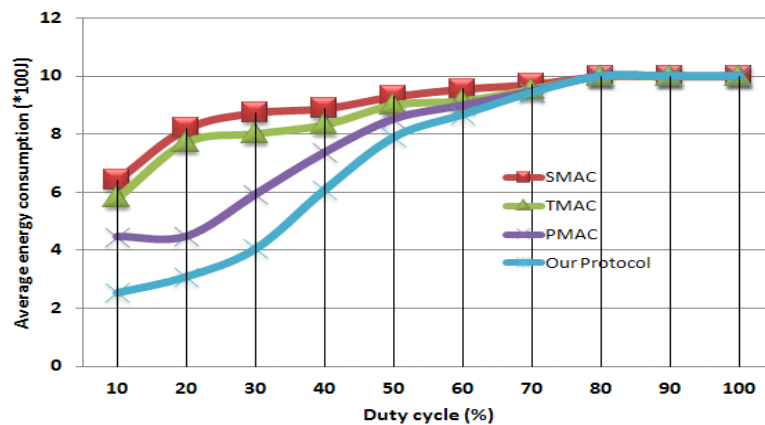

Fig. 7. Average energy consumption with different duty cycles.

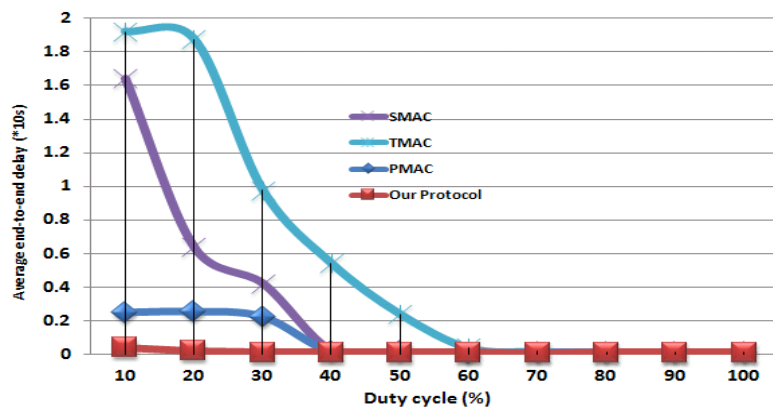

Fig. 8. Average end-to-end delay with different duty cycles.

In our simulation, we have considered different set of neighbors that are attached to each allocator. We have simulated our protocol with different topologies and have compared the same with other MAC protocols. As shown in Fig. 9, we find that more amount of energy is consumed for more number of neighbors. PMAC spends less power than SMAC and TMAC. According to our protocol, if any two nodes wake up at a single slot and we achieve better energy saving than others. The measurement of end-to-end delay is analyzed and presented in Fig. 10. Since, more collision occurs due to increase in neighbor numbers, we can see that the increase in number of neighbors affect the end-to-end delay.

Though SMAC has less amount of end-to-end delay than TMAC, it is almost same when neighbor numbers is within 15 or 20. It is observed that our protocol has better performance over other MAC protocols, as perfect node scheduling and efficient slot allocation among nodes are made.

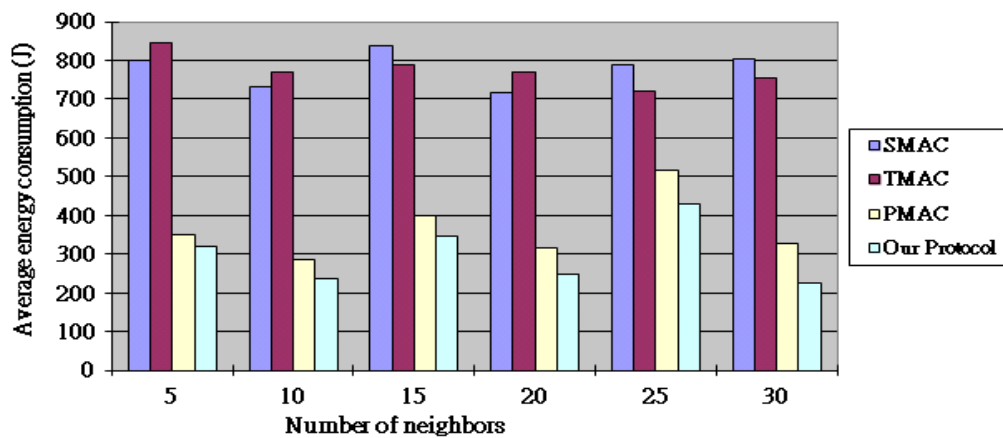

Fig. 9. Average energy consumption with different number of neighbors.

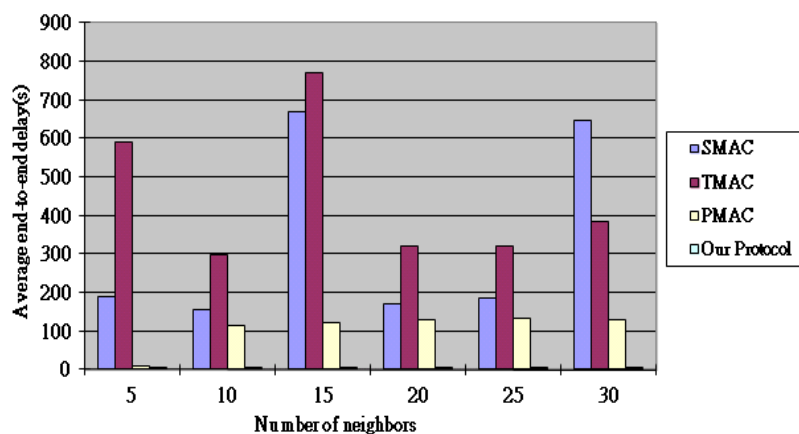

Fig. 10. Average end-to-end delay with different number of neighbors.

## 5. Conclusions

In this paper, a slotted MAC protocol based on Round-Robin scheduling algorithm is proposed. The main motive of our work is to minimize the energy consumption and end-to-end delay as compared to few well known MAC protocols of the wireless sensor network. We use a slotted method to allocate slots to the nodes based on their traffic load. At the same time, our protocol can strictly maintain fairness and no node will be in the starvation state. The major contribution of our work is to propose an efficient MAC protocol, which can still improve the energy wastage and latency due to collision under high traffic load. Our simulation results show that our protocol outperforms in terms of energy saving and end-to-end delay over other MAC protocols for different duty cycles and neighbor numbers.

## Acknowledgements

This research is co-sponsored by Chang Gung University grant (CGURP) UERPD2B0051 and NSC grants NSC100-2221-E-182-069 and NSC101-2923-E-182-001-MY3.

## References

- [1]. C. J. Vieira, M. A. M. Coelho, D. C. da Silva, J. da Mata, Survey on Wireless Sensor Network Devices, in *Proceedings of the Emerging Technologies and Factory Automation*, Vol. 1, September 2003, pp. 537-544.
- [2]. Mainwaring A, Polastre J, Szewczyk R, Culler D, Anderson J, Wireless Sensor Networks for Habitat Monitoring, in *Proceedings of the 1<sup>st</sup> ACM International Workshop on Wireless Sensor Networks and Applications*, Atlanta, USA, Sept, 2002, pp. 88-97.
- [3]. Perrig A, Szewczyk R, Tygar J. D., Wen V, Culler D. E., SPINS: Security Protocols for Sensor Networks. *Wireless Networks*, 8, 5, Sept, 2002, pp. 521-534.
- [4]. He T, Krogh B, Krishnamurthy S, Stankovic J A, Abdelzaher T, Luo L, Stoleru R, Yan T, Gu L, Hui J, Energy-Efficient Surveillance System Using Wireless Sensor Networks, in *Proceedings of the 2<sup>nd</sup> International Conference on Mobile Systems, Applications, and Services*, Boston, MA, USA, 2004, pp. 270-283.
- [5]. I. Demirkol, C. Ersoy and F. Alagoz, MAC protocols for wireless sensor networks: A survey, *IEEE Communications Magazine*, 44, 4, 2006, pp. 115-121.
- [6]. W. Ye, J. Heidemann and D. Estrin, \Medium access control with coordinated adaptive sleeping for wireless sensor networks, *IEEE/ACM Transactions on Networking*, Apr. 2004.
- [7]. W. Heinzelman, R. A. Chandrakasan and H. Balakrishnan, Energy-efficient communication protocol for wireless microsensor networks, *IEEE Transactions on Wireless Communications*, 2000.
- [8]. T. van Dam and K. Langendoen, An Adaptive Energy-Efficient MAC Protocol for Wireless Sensor Networks, in *Proceeding of the ACM SenSys*, November 2003.
- [9]. T. Zheng, S. Radhakrishnan, and V. Sarangan, PMAC: An Adaptive Energy-Efficient MAC Protocol for Wireless Sensor Networks, in *Proceedings. of the IEEE International Parallel and Distributed Processing Symposium (IPDPS' 2005)*, 2005.
- [10]. Muneeb Ali and Zartash Afzal Uzmi, Medium access control with mobility-adaptive mechanisms for wireless sensor networks, *International Journal of Sensor Networks*, Vol. 1 Issue 3/4, September 2006.
- [11]. Tijs van Dam and Koen Langendoen, An Adaptive Energy Efficient MAC Protocol for Wireless Sensor Networks, in *Proceedings of the 1<sup>st</sup> International Conference on Embedded Networked Sensor Systems*, 2003.
- [12]. Andre Barroso, Utz Roedig and Cormac Sreenan,  $\mu$ -MAC: An Energy-Efficient Medium Access Control for Wireless Sensor Networks, in *Proceedings of the 2<sup>nd</sup> European Workshop on Wireless Sensor Networks*, pp. 70-80, 2005.
- [13]. Joseph Polastre, Jason Hill and David Culler, Versatile Low Power Media Access for Wireless Sensor Networks, in *Proceedings of the 2<sup>nd</sup> International Conference on Embedded Networked Sensor Systems*, 2004.
- [14]. Peng Lin, Chunming Qiao and Xin Wang, Medium Access Control With A Dynamic Duty Cycle For Sensor Networks, *IEEE Wireless Communications and Networking Conference*, 2004.
- [15]. The network simulator, ns-2, <http://www.isi.edu./nslam/ns/>

## Guide for Contributors

---

### Aims and Scope

*Sensors & Transducers Journal* (ISSN 1726-5479) provides an advanced forum for the science and technology of physical, chemical sensors and biosensors. It publishes state-of-the-art reviews, regular research and application specific papers, short notes, letters to Editor and sensors related books reviews as well as academic, practical and commercial information of interest to its readership. Because of it is a peer reviewed international journal, papers rapidly published in *Sensors & Transducers Journal* will receive a very high publicity. The journal is published monthly as twelve issues per year by International Frequency Sensor Association (IFSA). In addition, some special sponsored and conference issues published annually. *Sensors & Transducers Journal* is indexed and abstracted very quickly by Chemical Abstracts, IndexCopernicus Journals Master List, Open J-Gate, Google Scholar, etc. Since 2011 the journal is covered and indexed (including a Scopus, Embase, Engineering Village and Reaxys) in Elsevier products.

### Topics Covered

Contributions are invited on all aspects of research, development and application of the science and technology of sensors, transducers and sensor instrumentations. Topics include, but are not restricted to:

- Physical, chemical and biosensors;
- Digital, frequency, period, duty-cycle, time interval, PWM, pulse number output sensors and transducers;
- Theory, principles, effects, design, standardization and modeling;
- Smart sensors and systems;
- Sensor instrumentation;
- Virtual instruments;
- Sensors interfaces, buses and networks;
- Signal processing;
- Frequency (period, duty-cycle)-to-digital converters, ADC;
- Technologies and materials;
- Nanosensors;
- Microsystems;
- Applications.

### Submission of papers

Articles should be written in English. Authors are invited to submit by e-mail [editor@sensorsportal.com](mailto:editor@sensorsportal.com) 8-14 pages article (including abstract, illustrations (color or grayscale), photos and references) in both: MS Word (doc) and Acrobat (pdf) formats. Detailed preparation instructions, paper example and template of manuscript are available from the journal's webpage: <http://www.sensorsportal.com/HTML/DIGEST/Submission.htm> Authors must follow the instructions strictly when submitting their manuscripts.

### Advertising Information

Advertising orders and enquires may be sent to [sales@sensorsportal.com](mailto:sales@sensorsportal.com) Please download also our media kit: [http://www.sensorsportal.com/DOWNLOADS/Media\\_Kit\\_2012.pdf](http://www.sensorsportal.com/DOWNLOADS/Media_Kit_2012.pdf)

***Digital Sensors and Sensor Systems: Practical Design*** will greatly benefit undergraduate and at PhD students, engineers, scientists and researchers in both industry and academia. It is especially suited as a reference guide for practitioners, working for Original Equipment Manufacturers (OEM) electronics market (electronics/hardware), sensor industry, and using commercial-off-the-shelf components, as well as anyone facing new challenges in technologies, and those involved in the design and creation of new digital sensors and sensor systems, including smart and/or intelligent sensors for physical or chemical, electrical or non-electrical quantities.

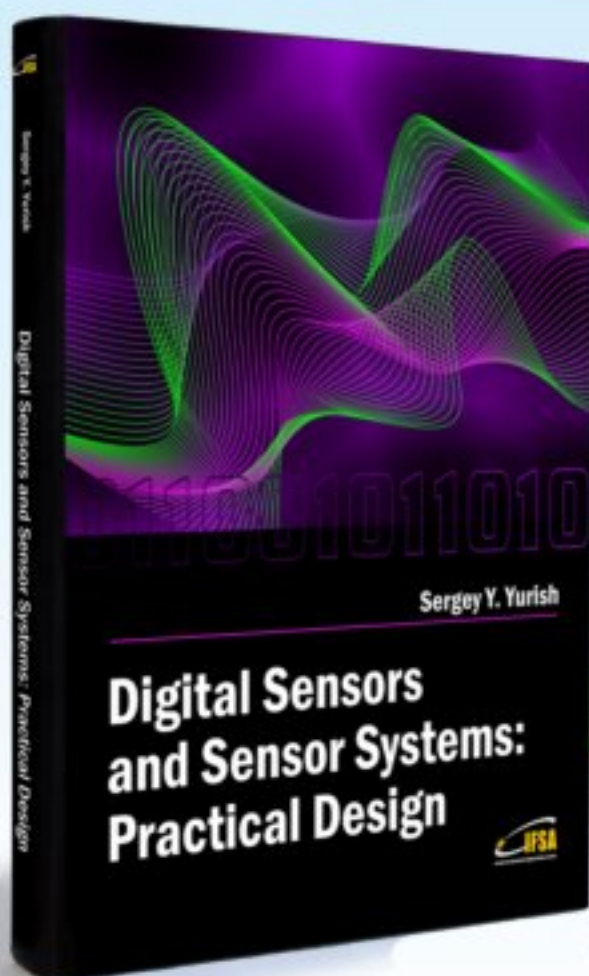

*"It is an outstanding and most completed practical guide about how to deal with frequency, period, duty-cycle, time interval, pulse width modulated, phase-shift and pulse number output sensors and transducers and quickly create various low-cost digital sensors and sensor systems ..."* (from a review)

Order online:

[http://www.sensorsportal.com/HTML/BOOKSTORE/Digital\\_Sensors.htm](http://www.sensorsportal.com/HTML/BOOKSTORE/Digital_Sensors.htm)



[www.sensorsportal.com](http://www.sensorsportal.com)